

SIZE	DIAMETER "D"	RADIUS "R"	WALL THICKNES	PART NUMBER	WEIGHT (LBS.)
4"	4.5"	72"	.096"	FGHW-49072	13.583
5"	5.563"	72"	.110"	FGHW-59072	19.144
6"	6.625"	72"	.110"	FGHW-69072	26.07
8"	8.625"	72"	.125"	FGHW-89072	38.988

DEEP SOCKET PVC COUPLING

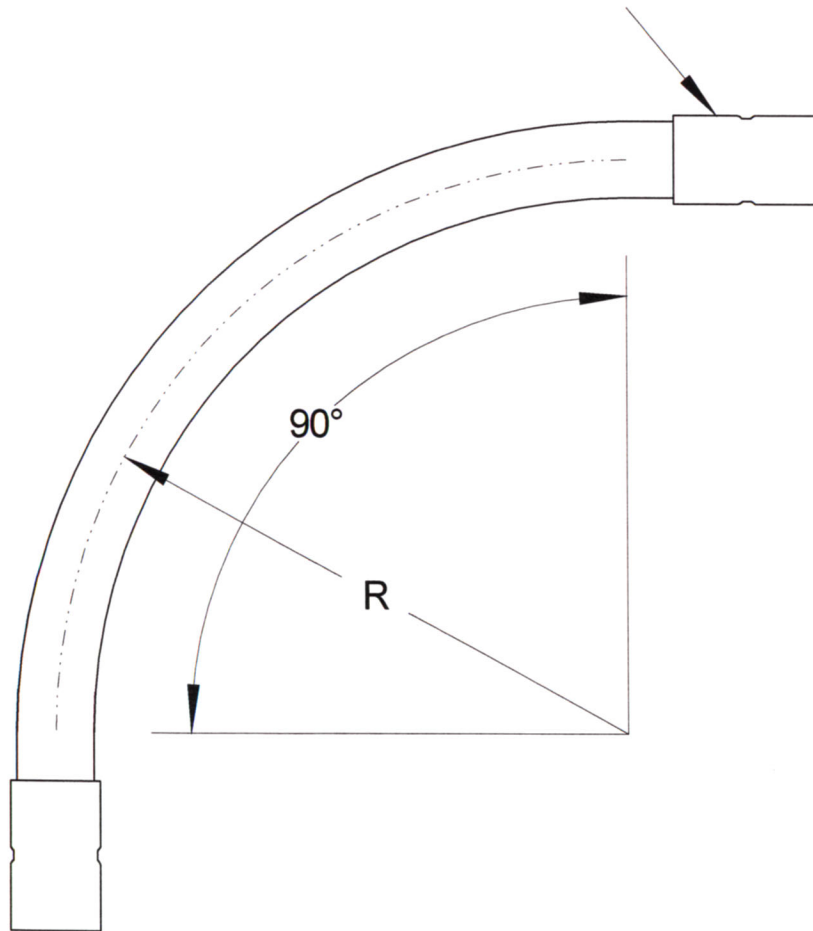

DEEP SOCKET PVC COUPLINGS CONFORM TO UL 651 SPECIFICATIONS

**RACEWAYS TECHNOLOGY
& MFG., INC.**

TACOMA, WA

90 DEGREE FIBERGLASS ELBOW 72" RADIUS
(HEAVY WALL)

NO SCALE

RTP

2012