

SIZE	DIAMETER "D"	RADIUS "R"	TANGENT "T" (MIN.)	PART NUMBER	WEIGHT (LBS.)
1"	1.315"	18"	1.875"	DB-13018	0.18
1 1/2"	1.9"	18"	2"	DB-1503018	0.28
2"	2.375"	18"	2"	DB-23018	0.43
3"	3.5	18"	3.125"	DB-33018	1.188
4"	4.5"	18"	3.375"	DB-43018	1.56

INTEGRAL COUPLING

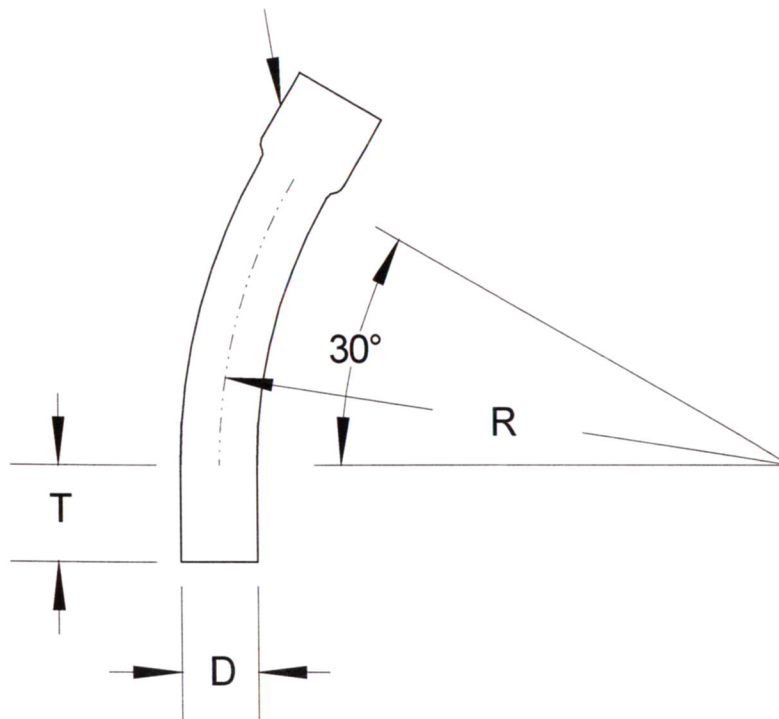

**RACEWAYS TECHNOLOGY
& MFG., INC.**

TACOMA, WA

30 DEGREE DB120 PVC ELBOW 18" RADIUS

NO SCALE

RTP

2012