

SIZE	DIAMETER "D"	RADIUS "R"	TANGENT "T" (MIN.)	PART NUMBER	WEIGHT (LBS.)
1/2"	.84"	48"	1.5"	S40W-053048	0.354
3/4"	1.05"	48"	1.5"	S40W-0753048	0.458
1"	1.315"	48"	1.875"	S40W-13048	0.688
1 1/4"	1.66"	48"	2"	S40W-1253048	0.917
1 1/2"	1.9"	48"	2"	S40W-1503048	1.079
2"	2.375"	48"	2"	S40W-23048	1.448
2 1/2"	2.875"	48"	3"	S40W-2503048	2.354
3"	3.5	48"	3.125"	S40W-33048	3.553
4"	4.5"	48"	3.375"	S40W-43048	5.075
5"	5.563"	48"	3.625"	S40W-53048	7.963
6"	6.625"	48"	3.75"	S40W-63048	12.19
8"	8.625"	48"	6.625"	S40W-83048	19.278

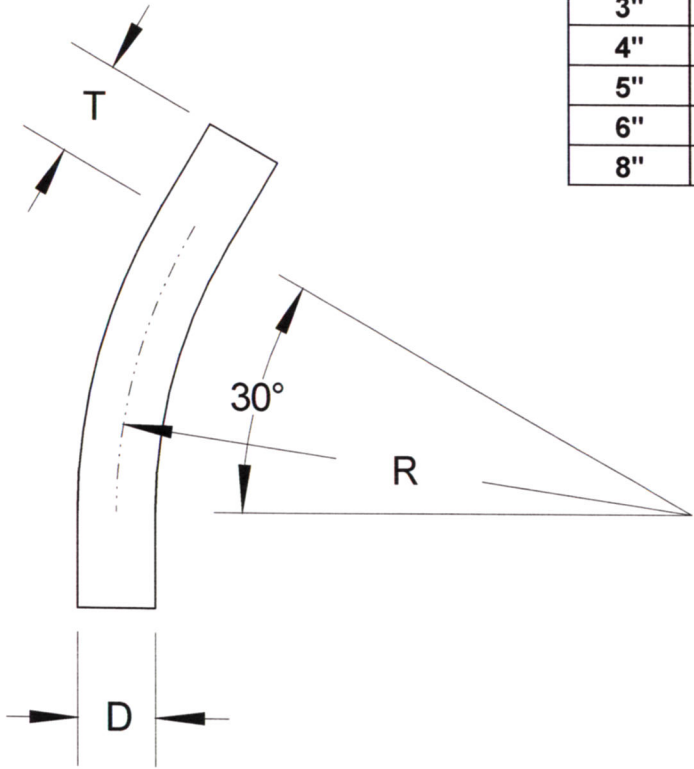

INTEGRAL COUPLINGS AVAILABLE ON REQUEST

**RACEWAYS TECHNOLOGY
& MFG., INC.**
TACOMA, WA

30 DEGREE S/40 NSF PVC ELBOW 48" RADIUS

NO SCALE	RTP	2012
----------	-----	------