

ALL S/80 CONDUIT ELBOWS AND SWEEPS MANUFACTURED BY RACEWAYS TECHNOLOGY ARE MADE FROM ETL OR UL LISTED PVC PIPE TO UL 651 SPECIFICATIONS.

SIZE	DIAMETER "D"	RADIUS "R"	TANGENT "T" (MIN.)	PART NUMBER	WEIGHT (LBS.)
1/2"	.84"	36"	1.5"	S80-059036	1.046
3/4"	1.05"	36"	1.5"	S80-0759036	1.394
1"	1.315"	36"	1.875"	S80-19036	2.091
1 1/4"	1.66"	36"	2"	S80-1259036	2.838
1 1/2"	1.9"	36"	2"	S80-1509036	3.436
2"	2.375"	36"	2"	S80-29036	4.78
2 1/2"	2.875"	36"	3"	S80-2509036	7.27
3"	3.5	36"	3.125"	S80-39036	9.759
4"	4.5"	36"	3.375"	S80-49036	14.24
5"	5.563"	36"	3.625"	S80-59036	19.767
6"	6.625"	36"	3.75"	S80-69036	50.05

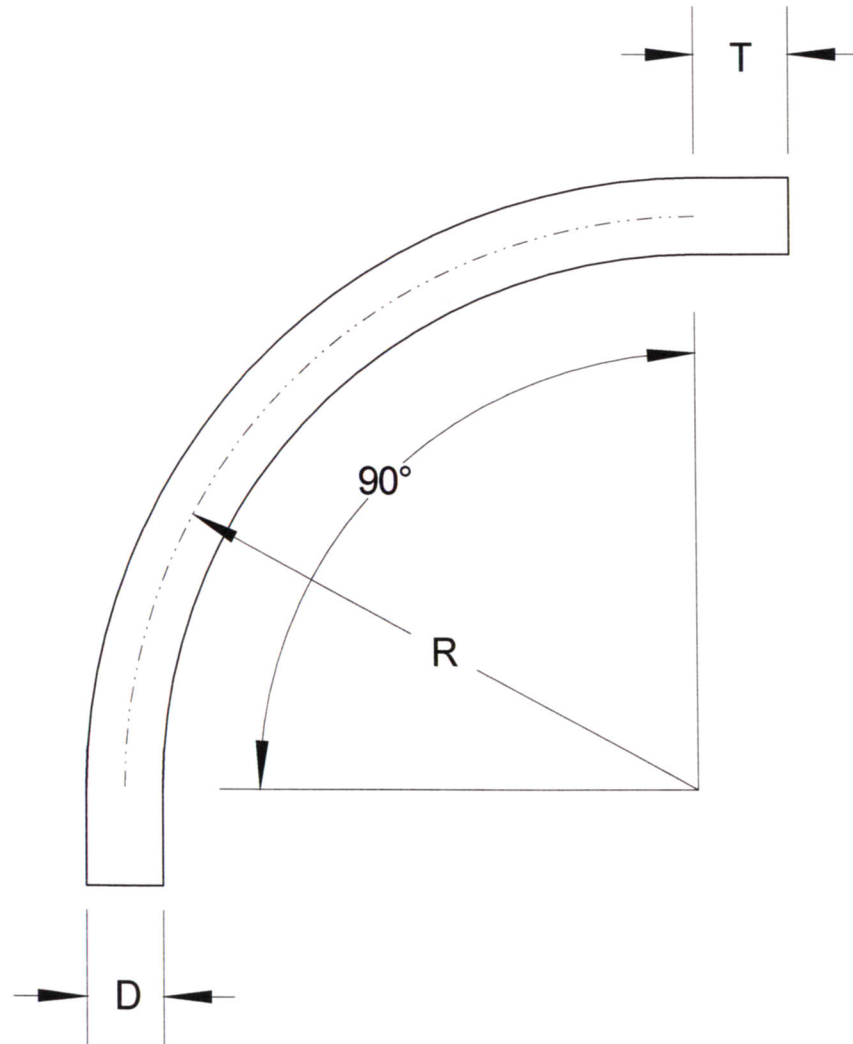

INTEGRAL COUPLINGS AVAILABLE ON REQUEST  
INTEGRAL COUPLINGS CONFORM TO UL 651 SPECIFICATIONS

**RACEWAYS TECHNOLOGY  
& MFG., INC.**  
TACOMA, WA

90 DEGREE S/80 PVC ELBOW 36" RADIUS

NO SCALE

RTP

2012