

SIZE	DIAMETER "D"	RADIUS "R"	TANGENT "T" (MIN.)	PART NUMBER	WEIGHT (LBS.)
4"	4.35	24"	3.25	CD-42224	2.232

INTEGRAL COUPLING

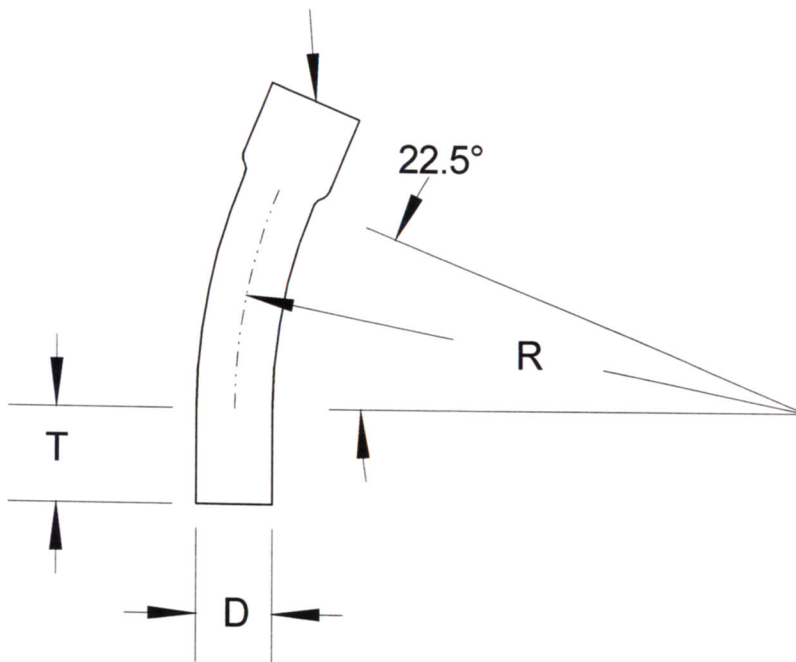

**RACEWAYS TECHNOLOGY
& MFG., INC.**
TACOMA, WA

22.5 DEGREE C-DUCT PVC ELBOW 24" RADIUS

NO SCALE

RTP

2012