

SIZE	DIAMETER "D"	RADIUS "R"	TANGENT "T" (MIN.)	PART NUMBER	WEIGHT (LBS.)
1 1/4"	1.66"	72"	2"	S40GS-1254572	2.28
1 1/2"	1.9"	72"	2"	S40GS-1504572	2.76
2"	2.375"	72"	2"	S40GS-24572	3.66
3"	3.5"	72"	3.125"	S40GS-34572	8.28
4"	4.5"	72"	3.375"	S40GS-44572	12.805

INTEGRAL COUPLING

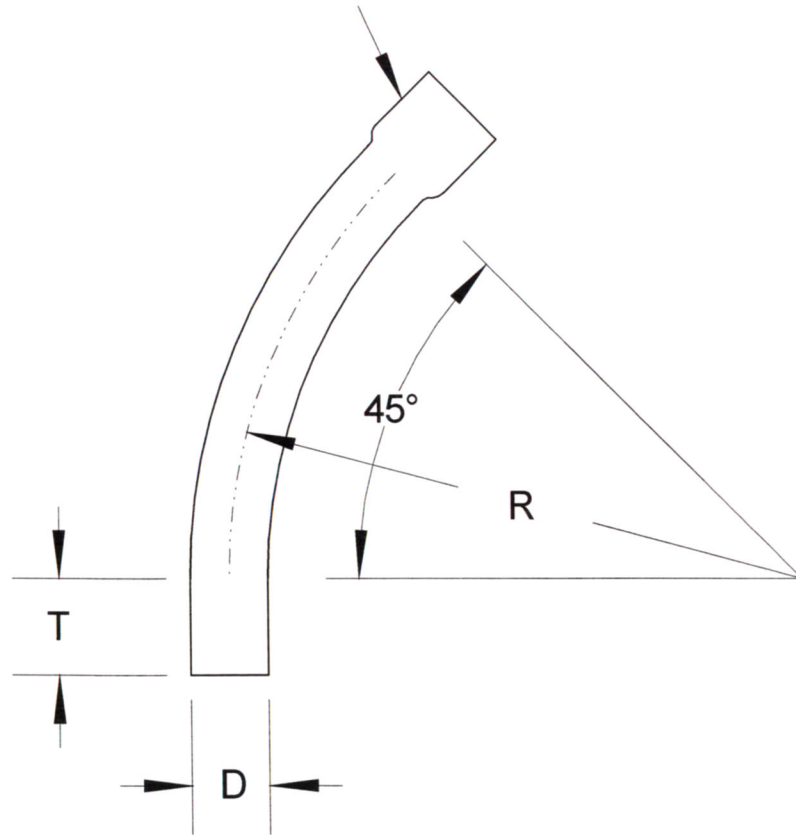

**RACEWAYS TECHNOLOGY  
& MFG., INC.**

TACOMA, WA

45 DEGREE S/40 GAS PVC ELBOW 72' RADIUS

NO SCALE

RTP

2012